

Optimate High Performance
Battery Chargers



THE COMPETITIVE ADVANTAGE



BRAND:

- ✓ EXCLUSIVE TO PARTS CANADA.
- ✓ CO-BRANDED OUR MOST POPULAR PRODUCTS.

ADVANTAGE:

- ✓ **NEW** LOWER PRICING.
- ✓ BETTER BOOKING PROGRAM PRICING.

THE COMPETITIVE ADVANTAGE



Percentage of sales

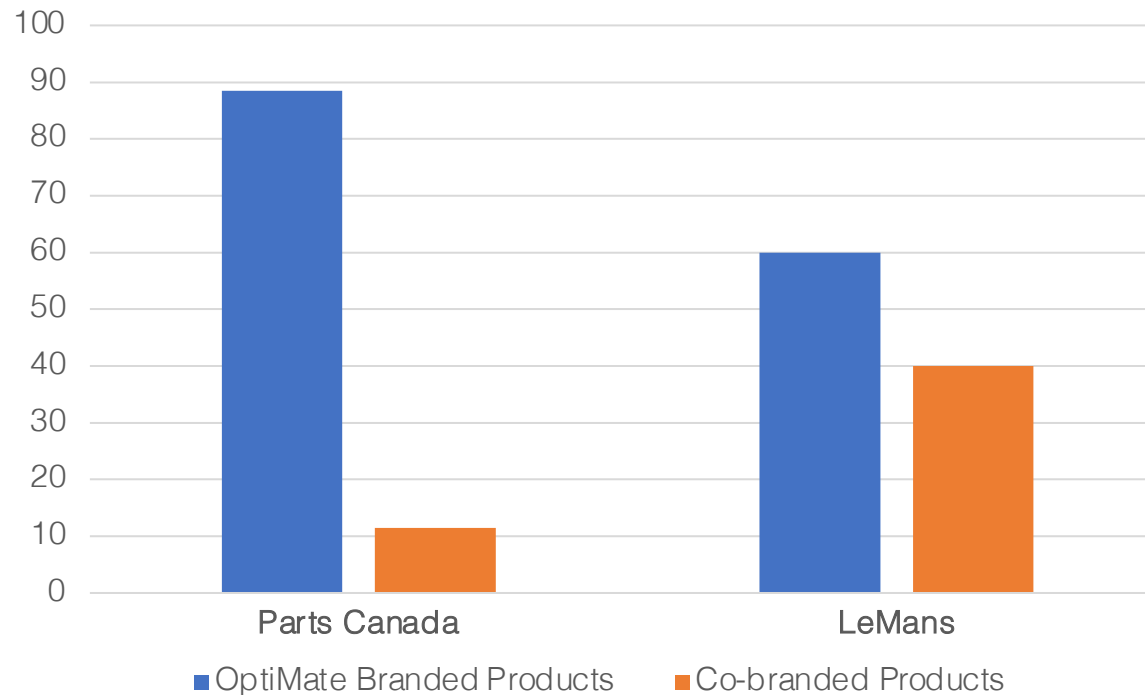



TecMate Part # **TM413**
Parts Canada Part # 3807-0441
MSRP: CA\$56.95

**AUTOMATICALLY ADAPTS TO
PB OR LFP BATTERY**

DUO = $\begin{matrix} \text{Standard} \\ \text{12V} \\ \text{Pb} \end{matrix} + \begin{matrix} \text{Lithium} \\ \text{12.8V} \\ \text{LFP} \end{matrix}$

SAFE TO LEAVE CONNECTED
Full electronic protection

✓SAFE

MAINTAINS BATTERY at full
charge and good health

⚡ 24-7



TecMate Part # **TM611**
Parts Canada Part # 3807-0502
MSRP: CA\$56.95



**AUTOMATICALLY ADAPTS TO
PB OR LFP BATTERY**

$$DUO = \begin{matrix} \text{Standard} \\ \mathbf{12V} \\ \text{Pb} \end{matrix} + \begin{matrix} \text{Lithium} \\ \mathbf{12.8V} \\ \text{LFP} \end{matrix}$$

SAFE TO LEAVE CONNECTED
Full electronic protection



MAINTAINS BATTERY at full
charge and good health



THE MOST
POPULAR
MOTORCYCLE
CHARGER
WORLD-WIDE!

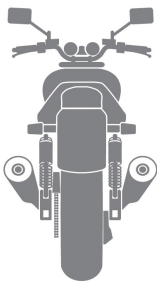

TecMate Part # **TM441**
Parts Canada Part # 3807-0257
MSRP: CA\$83.95



WAKES UP NEGLECTED BATTERY
and safely delivers reconditioning
charge

A diagram showing two batteries. The left battery is labeled with 'x' marks, indicating it is neglected. A green arrow points from it to the right battery, which has a smiley face, indicating it is reconditioned.

TESTS BATTERY
State Of Health

A diagram showing a battery with a red arrow pointing to a test icon labeled "S.O.H". Below the battery are three icons: a red triangle with an exclamation mark (warning), a red triangle with a sad face (failure), and a green triangle with a smiley face (success).

LOW VOLTAGE SAVE from
as low as 2V

A diagram showing a battery with a red arrow pointing to a "2V" label, indicating the low voltage save feature.

BETTER

12V / 12.8V 0.6A



THE DUO MAINTAINER

LOW VOLT SAVE
(FROM 4V)

CHARGE Pb Li



'24/7 365 SAFE' MAINTAIN

SKU: TM611
#3807-0502



Optimate 1
(DUO)

12V / 12.8V 0.6A



THE DUO MAINTAINER

LOW VOLT SAVE
(FROM 4V)

CHARGE Pb Li



'24/7 365 SAFE' MAINTAIN

SKU: TM413
#3807-0441



Optimate 1
(DUO)

BEST

12V 0.8A



THE BATTERY SAVER

LOW VOLT SAVE
(FROM 2V)

CHARGE & TEST Pb



DESULFATES &
RECOVERS

'24/7 365 SAFE'
MAINTAIN

SKU: TM441
#3807-0257



Optimate 3



TecMate Part # **TM613**
Parts Canada Part # 3807-0544
MSRP: CA\$56.95



**AUTOMATICALLY ADAPTS TO
PB OR LFP BATTERY**

DUO = $\begin{matrix} \text{Standard} \\ \text{12V} \\ \text{Pb} \end{matrix} + \begin{matrix} \text{Lithium} \\ \text{12.8V} \\ \text{LFP} \end{matrix}$

SAFE TO LEAVE CONNECTED
Full electronic protection

✓SAFE

MAINTAINS BATTERY at full
charge and good health

⚡ 24-7

THE MOST
POPULAR
MOTORCYCLE
CHARGER
WORLD-WIDE!

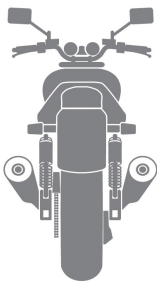

TecMate Part # **TM443**
Parts Canada Part # **3807-0254**
MSRP: CA\$83.95



WAKES UP NEGLECTED BATTERY
and safely delivers reconditioning
charge

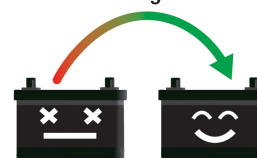

TESTS BATTERY
State Of Health

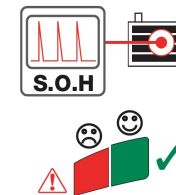

LOW VOLTAGE SAVE from
as low as 2V

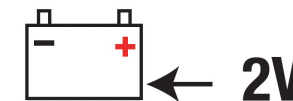

12V 4A
6 STEPS



TecMate Part # **TM231**
Parts Canada Part # **3807-0467**
MSRP: CA\$105.95



MAINTAINS BATTERY at full
charge and good health



SAFE TO LEAVE CONNECTED
Full electronic protection



TESTS battery State Of Health

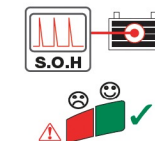

GOOD

12V / 12.8V 0.6A

THE DUO MAINTAINER

LOW VOLT SAVE (FROM **4V**)

CHARGE **Pb Li**



'24/7 365
SAFE'
MAINTAIN



SKU: TM613
#3807-0544

Optimate 1
DUO

BETTER

12V 0.8A

THE BATTERY SAVER

LOW VOLT SAVE
(FROM **2V**)

CHARGE & TEST **Pb**



DESULFATES
& RECOVERS

'24/7 365
SAFE'
MAINTAIN



SKU: TM443
#3807-0254

Optimate 3

BEST

12V 4A

THE POWER CHARGER

LOW VOLT SAVE
(FROM **2V**)

CHARGE & TEST **Pb**



'24/7 365
SAFE'
MAINTAIN

EXTRA:
HANDLEBAR
HANGING HOOK
INCLUDED!





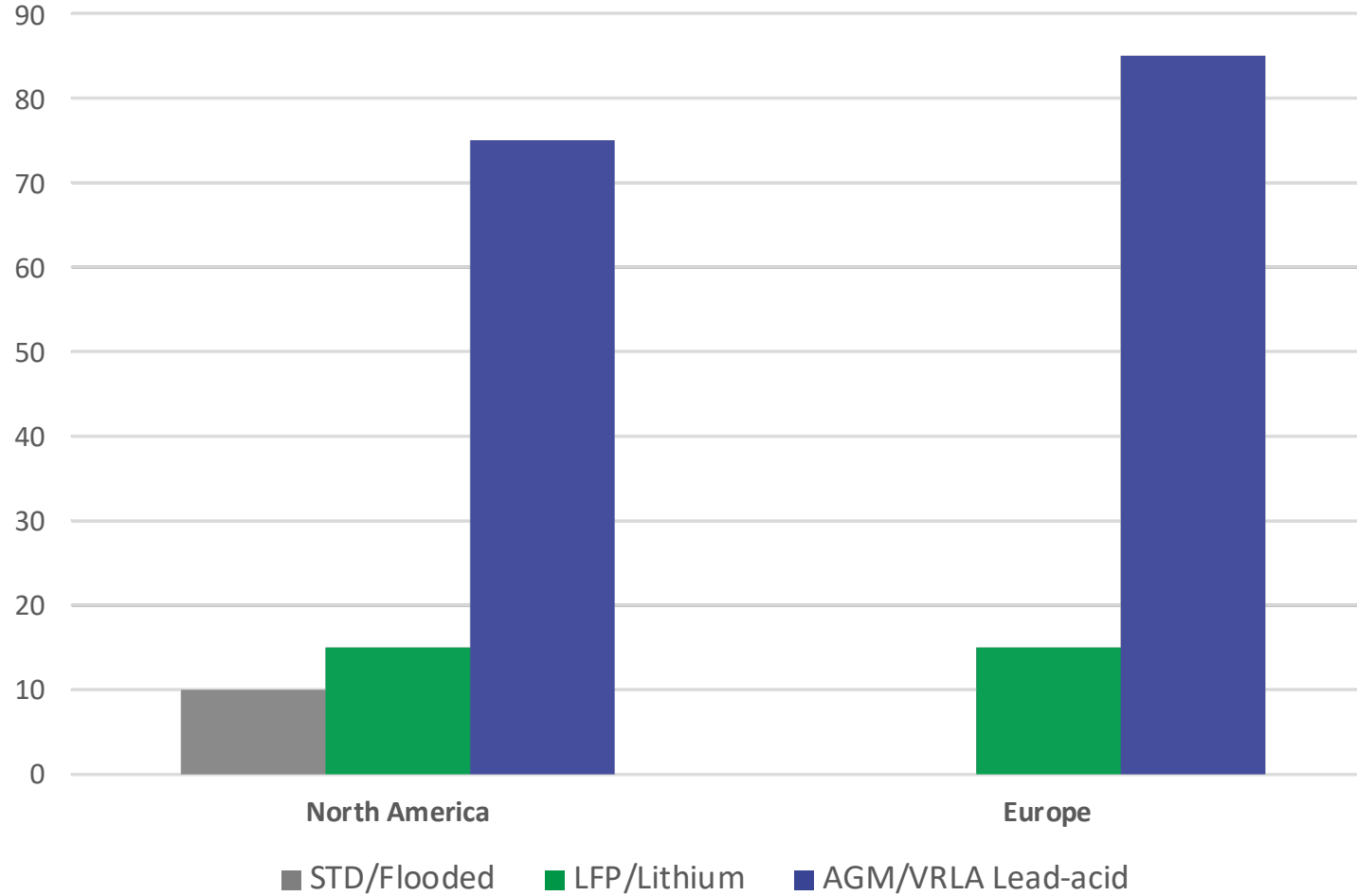

SKU: TM231
#3807-0467

Optimate 5

BATTERY POPULATION



LITHIUM BATTERY POPULATION

|  |  |  |  |  |  |  |  |  |  |
|--|---|---|---|---|---|---|---|---|---|
| TIGER 1200 | PANIGALE | S 1000 RR | CRF-450X | 350 SX-F | TE 300 | KX 250 | Stock in every bike | Ryker | YZ-450F |
| SPEED TRIPLE | 1099 | M 1000 RR | CRF-250X | 450 SX-F | TE 250 | KX 450SR | | | YZ-250F |
| | V4 R | R 1250 GS | AFRICA TWIN ES | 690 ENDURO | FX 350 | NINJA | | | YZ-450FX |
| | | *R 1300 GS? | AFRICA TWIN | 300 XC-W | FX 300 | KLX 300R | | | |
| | | | CBR1000RR | 300 SX | | | | | |
| | | | CRF-450L | | | | | | |

- ✓ DELIVERED FROM THE FACTORY WITH LITHIUM BATTERY.
- ✓ EVERY MANUFACTURER ADDING MORE BIKES DAILY.
- ✓ ALL BIKES NOW HAVE MORE OPTIONS FOR AFTERMARKET LITHIUM BATTERIES.

QUESTIONS?



GOOD

Pb 6-cell

12V AGM STD GEL

12V / 12.8V 0.6A BRONZE

LOW VOLT SAVE
(FROM 4V)

CHARGE Pb Li

'24/7 365 SAFE'
MAINTAIN

SKU: TM409
#3807-0431



Optimate 1
DUO

12.8V LFP LiFe LiFePO₄

Li 4-cell

BETTER

Pb 6-cell

12V AGM STD GEL

12V / 12.8V 2A BRONZE

LOW VOLT SAVE
(FROM 4V)

CHARGE Pb Li

'24/7 365 SAFE'
MAINTAIN

SKU: TM551
#3807-0572



Optimate 2
DUO 12V 2A

12.8V LFP LiFe LiFePO₄

Li 4-cell

BEST

12V 0.8A SILVER

LOW VOLT SAVE
(FROM 2V)

CHARGE & TEST
Pb

'24/7 365 SAFE'
MAINTAIN

SKU: TM431
#3807-0261



Optimate 3

12.8V 0.8A LITHIUM

LOW VOLT SAVE
(FROM 0.5V)

CHARGE & TEST Li

'24/7 365 SAFE'
MAINTAIN

SKU: TM471
#3807-0265



Optimate LFP
lithium 4s 0.8A

ULTIMATE

SOMETHING
NEW!

Optimate4

quad program

PREMIUM EDITION

12V 1.25A
9 STEPS
12.8V 1.25A



TecMate Part # TM631-PR
LeMans Part #
MSRP: \$104.95 / CA\$115.95

THE WORLD'S MOST ADVANCED POWER-SPORT BATTERY CHARGER!

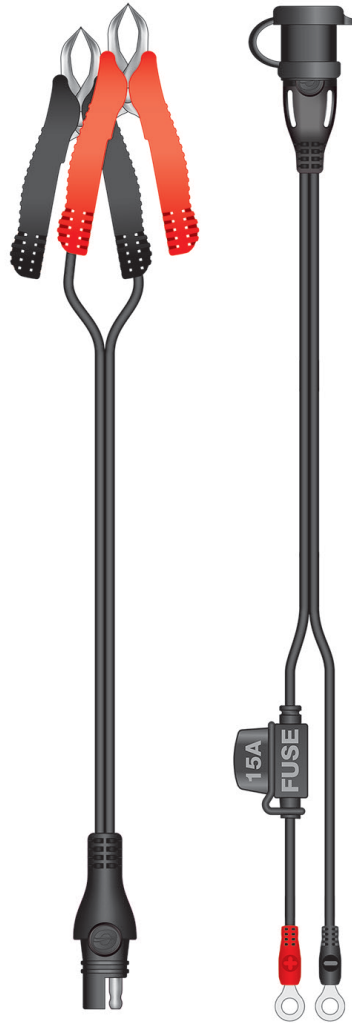
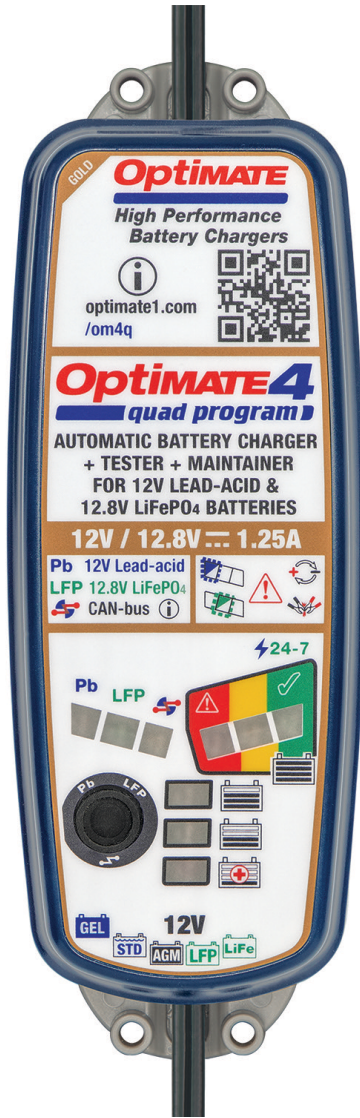

O-04 BATTERY CLIPS
O-01 BATTER LEAD



O-09 DIN BIKE PLUG



**BMW
MOTORRAD**



O-411 HANGING HOOK

OptiMATE4
quad program

PREMIUM EDITION

12V 1.25A
9 STEPS
12.8V 1.25A

quad program

TecMate Part # TM631-PR

LeMans Part #

MSRP: \$

THE WORLD'S MOST ADVANCED POWER-SPORT BATTERY CHARGER!

THE WORLD'S MOST ADVANCED POWER-SPORT BATTERY CHARGER!

1

SMART DESULPHATION



2

**BMW CAN-bus
COMPATIBLE**



3

LOW VOLT RECOVERY



4

**BMW CAN-bus
COMPATIBLE**

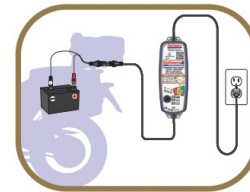
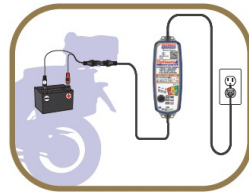

THE WORLD'S MOST ADVANCED POWER-SPORT BATTERY CHARGER!

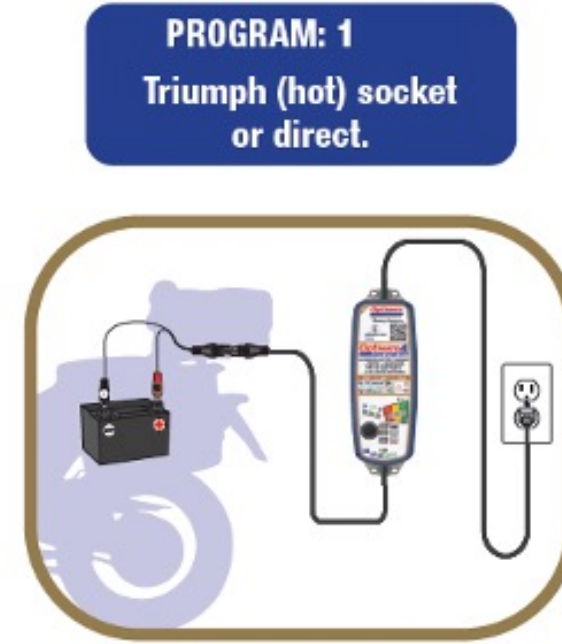

Pb - Lead-Acid

12V 4 - 60Ah

AGM GEL STD

THE WORLD'S MOST ADVANCED POWER-SPORT BATTERY CHARGER!



**PROGRAM: 2
(BMW CAN-bus)**



**BMW
MOTORRAD**

Pb - Lead-Acid

12V 4 - 60Ah

AGM GEL STD

THE WORLD'S MOST ADVANCED POWER-SPORT BATTERY CHARGER!

3
LOW VOLT RECOVERY



LFP **Bms** LFP



PROGRAM: 3
Triumph (hot) socket or direct.

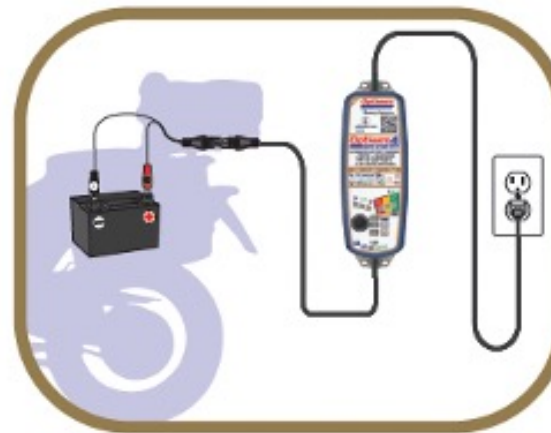

LFP - Lithium : LiFePO4

12.8V 2 - 15Ah

LFP **LiFe**

THE WORLD'S MOST ADVANCED POWER-SPORT BATTERY CHARGER!

4
**BMW CAN-bus
COMPATIBLE**



DIN LFP

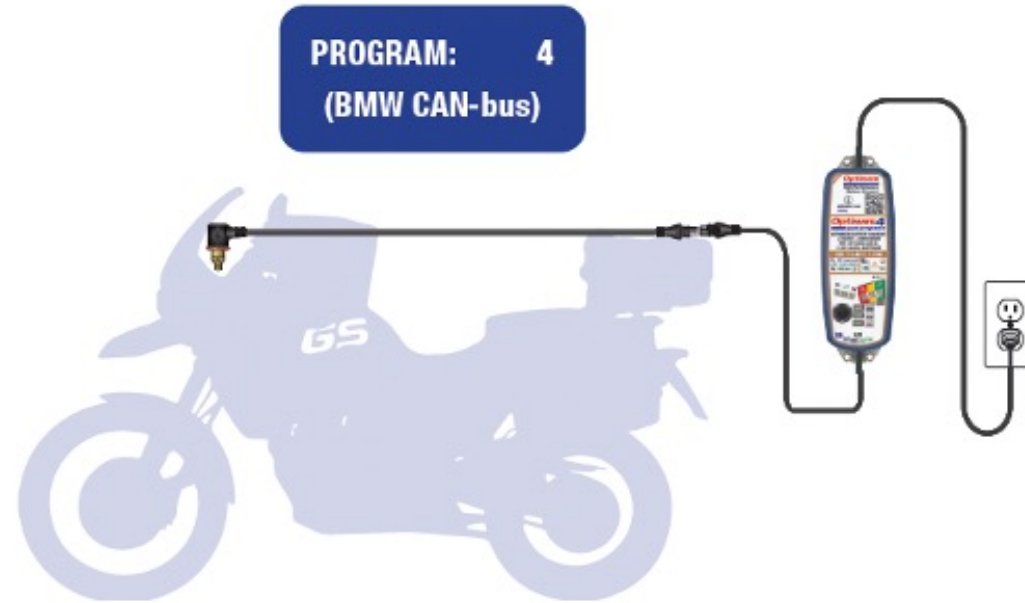

**BMW
MOTORRAD**

LFP - Lithium : LiFePO₄

12.8V 2 - 15Ah

LFP **LiFe**

SAVING 'DEAD' BATTERIES / OFF BIKE CHARGING:

1
SMART DESULPHATION



The diagram shows a pair of red and black alligator clips connected to a battery. The battery is depicted with a snowflake pattern on the left side and the letters 'Pb' on the right side, representing lead-acid technology.

3
LOW VOLT RECOVERY



The diagram shows a pair of red and black alligator clips connected to a battery. The battery is labeled 'LFP' and 'Bms', representing Lithium Iron Phosphate technology with a Battery Management System.

**ALL BIKES
+
OUT OF BIKE
BMW AND TRIUMPH**

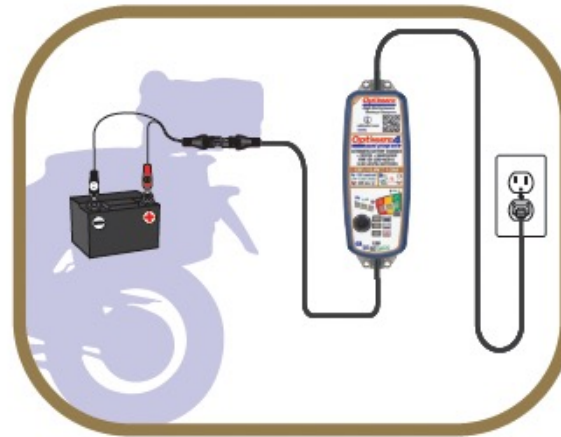

LOW VOLTAGE SAVE
from as low as 0.5V

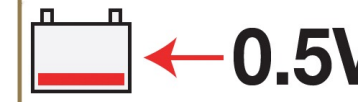

The diagram shows a battery icon with a red arrow pointing to it and the text '0.5V', indicating the low voltage threshold for the 'Low Voltage Save' feature.

IN BIKE CHARGING:

2

**BMW CAN-bus
COMPATIBLE**



4

**BMW CAN-bus
COMPATIBLE**



**BMW
MOTORRAD**



**PROGRAM: 2 OR 4
(BMW CAN-bus)**

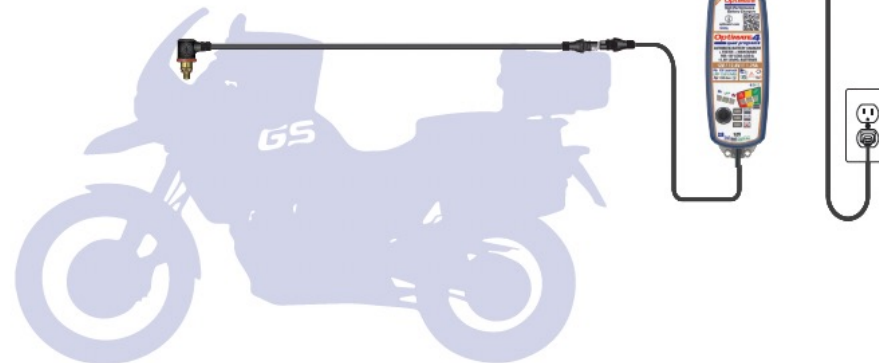

**PROTECTS YOUR BATTERY
against discharge by vehicle**

⚡ 24-7



THE WORLD'S MOST ADVANCED POWER-SPORT BATTERY CHARGER!

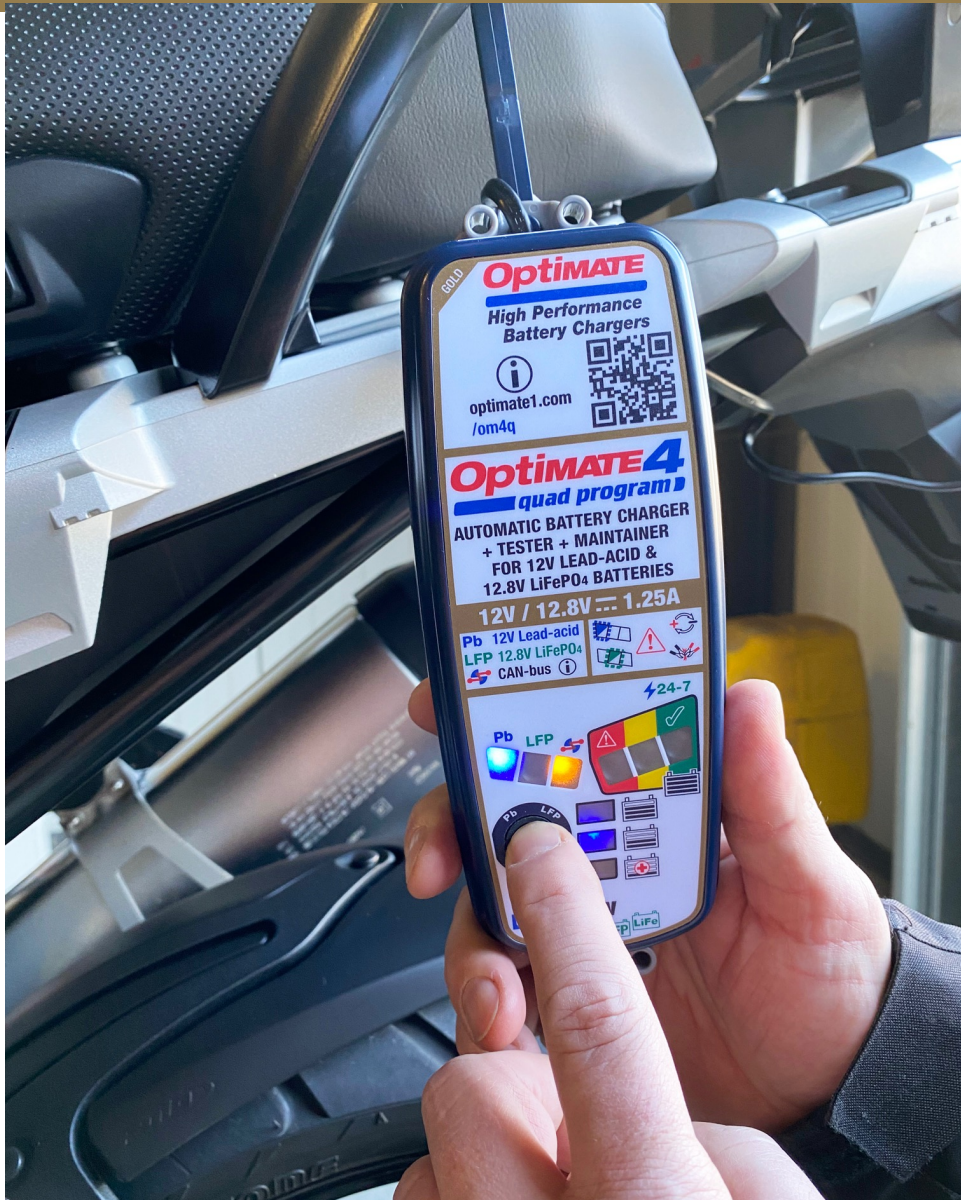

USB CHARGERS

Optimate
USB **O118**

USB-C

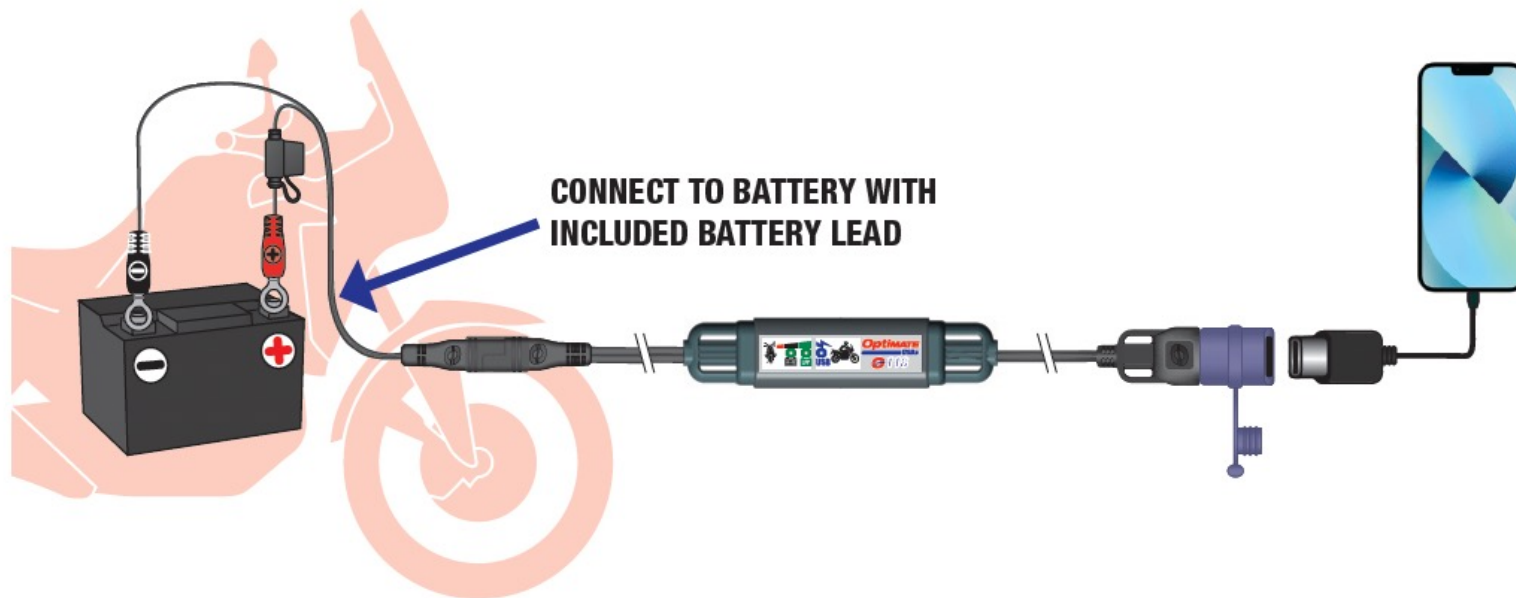

TecMate Part # **O-118**
LeMans Part # 3807-0664
MSRP: \$38.95 / CA\$49.95

WORKS WITH ALL POWERSPORT BATTERIES

12V Pb / AGM
12.8V Li / LFP

PROTECTS VEHICLE BATTERY turns on / off automatically

ON :   **USB** ✓
OFF:   **USB** ✗

TESTS VEHICLE BATTERY ready to start engine ✓



TRIUMPH DUCATI BMW

USB CHARGERS

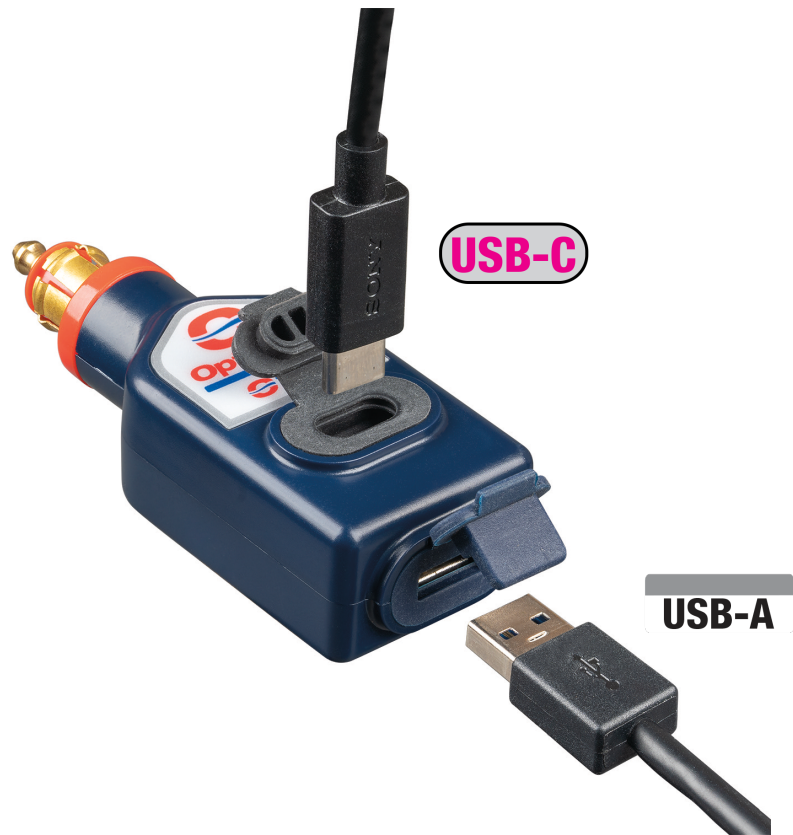

USB-C

USB-A

TecMate Part # **O-114**
 LeMans Part # 3807-0686
 MSRP: \$29.95 / CA\$38.95



USB-C

USB-A

TecMate Part # **O-119**
 LeMans Part # 3807-0687
 MSRP: \$29.95 / CA\$38.95



WORKS WITH ALL POWERSPORT BATTERIES

12V Pb / AGM

12.8V Li / LFP

PROTECTS VEHICLE BATTERY turns on / off automatically

ON: $\geq 13.3V$

OFF:



TESTERS

BATTERY GOOD? No more guessing!





TESTERS

KNOW WHEN TO RECHARGE YOUR BATTERY



LED blinks next to battery type.



Charge when LED below blinks.



TESTERS

Optimate
monitor **O 126**

Battery status / charge system monitor
for 12V lead-acid & 12.8V lithium-ion,
with AUTO/DIN plug.

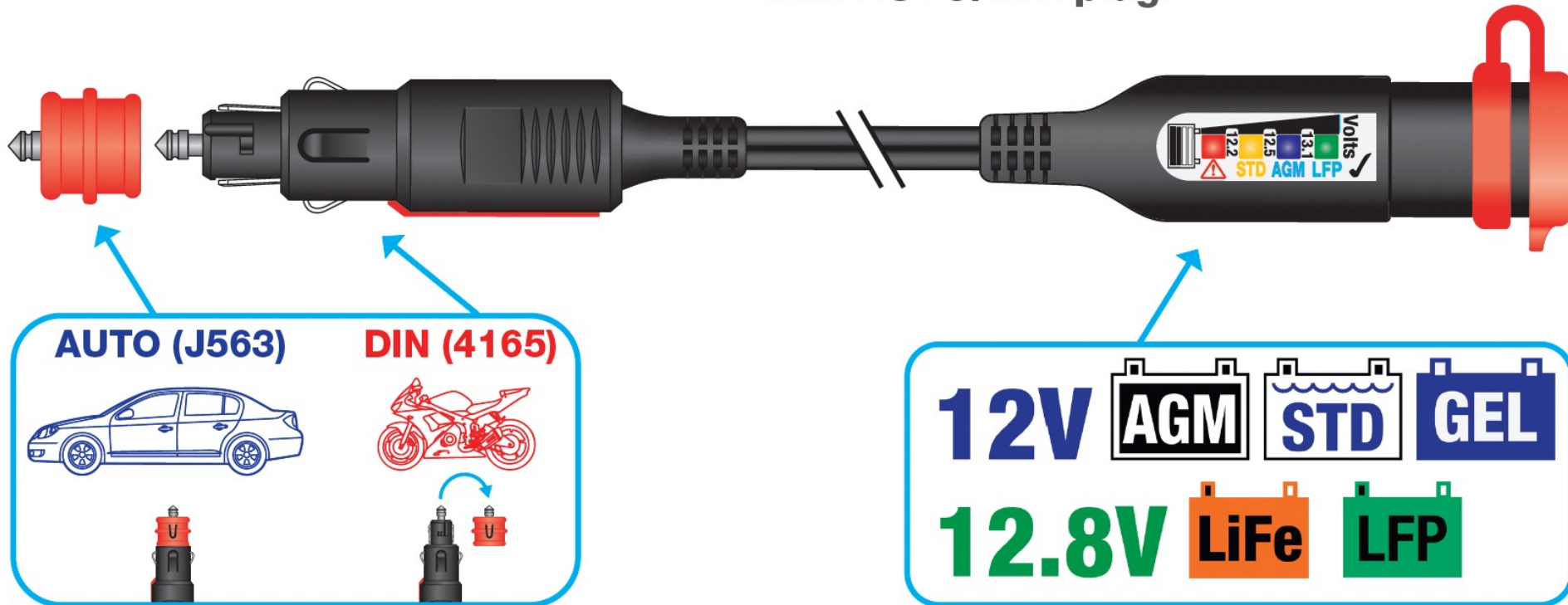

AUTO (J563)



DIN (4165)



12V



12.8V



TecMate Part # **O-126v2**
LeMans Part # 3807-0663
MSRP: \$22.95 / CA\$28.95



TESTERS

Optimate
monitor  **125**

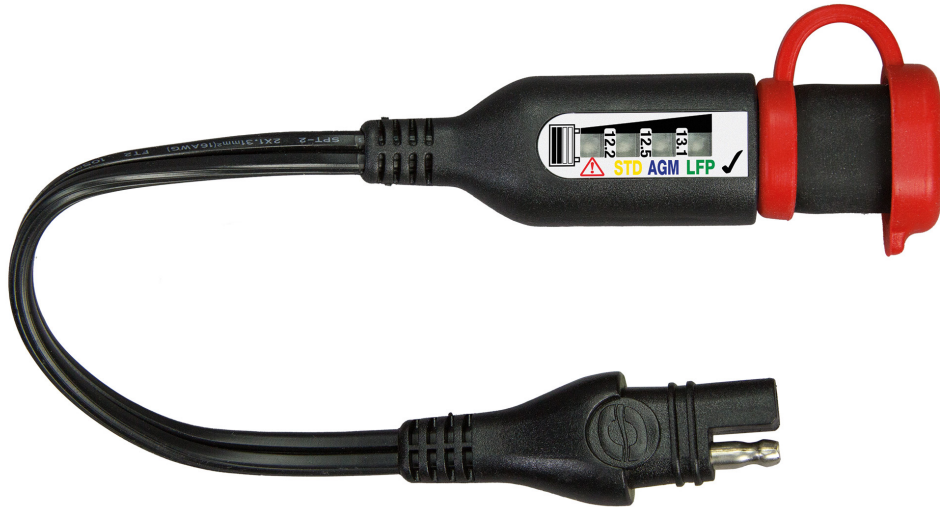

Plugs directly into any industry standard SAE battery lead!

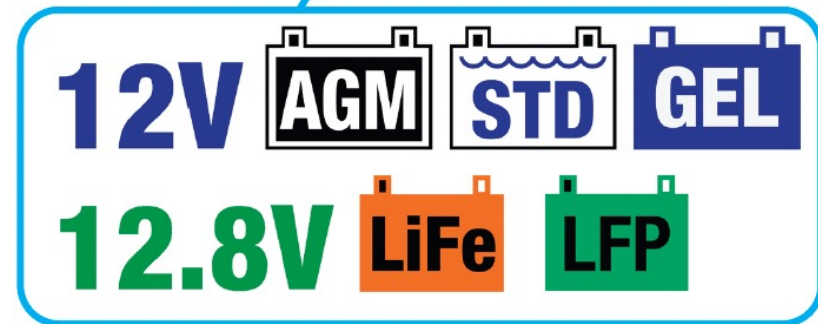

TecMate Part # **O-125v2**
LeMans Part # 3807-0663
MSRP: \$17.95 / CA\$23.95



TESTERS

NEW!

AS easy as 1-2-3!

1. Check state of battery
2. Check cranking/starter voltage
3. Check charge/running voltage

- ✓ *Improved programming.*
- ✓ *Easier identification of battery condition.*
- ✓ *The ultimate electrical testing too!*



TecMate Part # **TS-121**
LeMans Part # 3807-0245
MSRP: \$43.95 / CA\$51.95

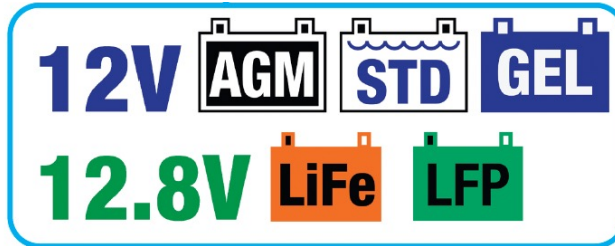

BATTERY LEAD SELECTOR



1/4" (M6) **POWERSPORT**



BUYING OPTIONS

1/4" (M6) / 5/16" (M8) **DUAL RING TECHNOLOGY**

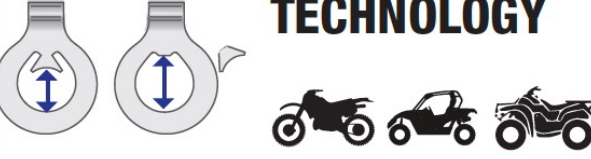

BUYING OPTIONS

5/16" (M8) / 3/8" (M10) **DUAL RING TECHNOLOGY**

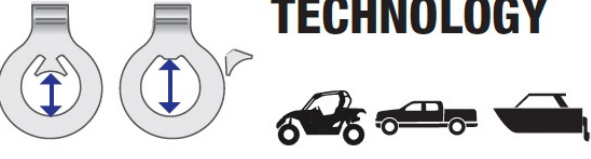

BUYING OPTIONS

20 UNITS **0-31sJAR** **#3807-0685**
#3807-0677 (CAN)

MOOSE UTILITY DIVISION

| QTY | MFG# | PART# |
|--------|-------|------------|
| 1 UNIT | 0-01M | #3807-0259 |

DRAG Specialties

| QTY | MFG# | PART# |
|-----------|------------|------------|
| 1 UNIT | 0-01D | #3807-0256 |
| 20 UNITS | 0-01DJAR | #3807-0352 |
| 120 UNITS | 0-01DJARx6 | #3807-0537 |

MOOSE UTILITY DIVISION

| QTY | MFG# | PART# |
|-----------|-------------|------------|
| 1 UNIT | 0-01NMJAR | #3807-0536 |
| 120 UNITS | 0-01NMJARx6 | #3807-0547 |

| QTY | MFG# | PART# |
|-----|------|-------|
| | | |

SLIM BATTERY LEAD

Optimate cable **O-31s JAR** (BLACK + GREEN CAP)

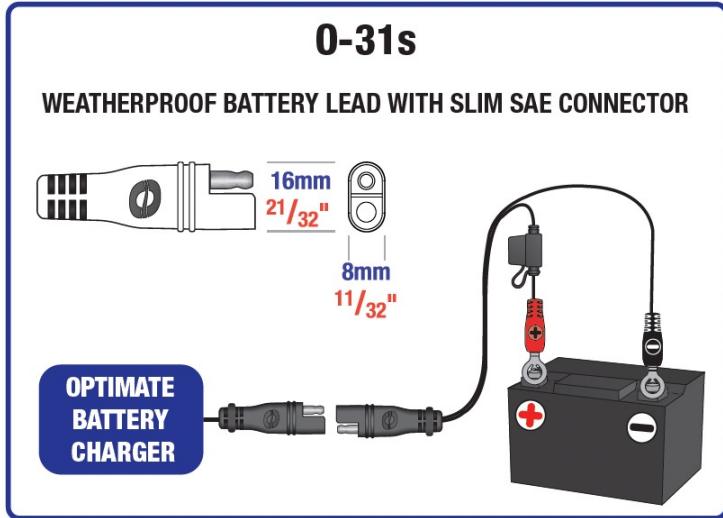

Standard:

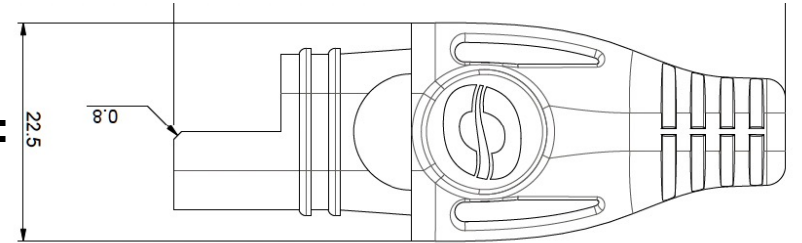

SLIM:

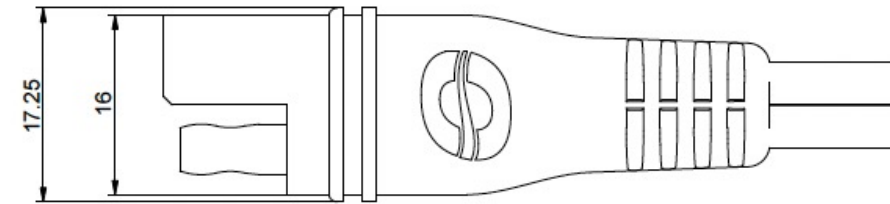

POWERSPORT / MOTO
M6 (1/4")

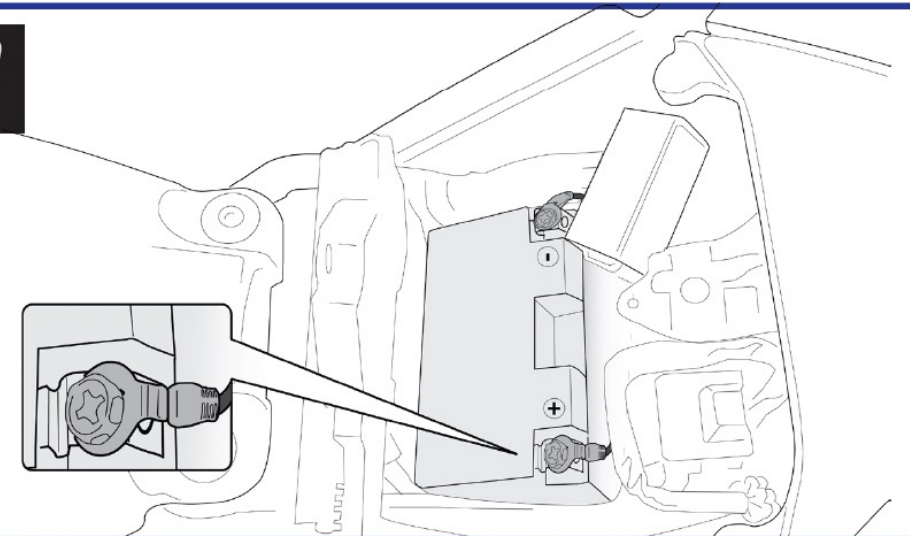

TecMate Part # **O-31sJAR**

LeMans Part # 3807-0685 / 3807-0677 CAN

MSRP: \$144.95 / CA\$166.95



WINTER IS COMING

GOOD

Pb 6-cell

12V AGM STD GEL

12V / 12.8V 0.6A BRONZE

LOW VOLT SAVE
(FROM 4V)

CHARGE Pb Li

'24/7 365 SAFE'
MAINTAIN

SKU: TM409
#3807-0431



Optimate 1
DUO

12.8V LFP LiFe LiFePO₄

Li 4-cell

BETTER

Pb 6-cell

12V AGM STD GEL

12V / 12.8V 2A BRONZE

LOW VOLT SAVE
(FROM 4V)

CHARGE Pb Li

'24/7 365 SAFE'
MAINTAIN

SKU: TM551
#3807-0572



Optimate 2
DUO 12V 2A

12.8V LFP LiFe LiFePO₄

Li 4-cell

BEST

12V 0.8A SILVER

LOW VOLT SAVE
(FROM 2V)

CHARGE & TEST
Pb

'24/7 365 SAFE'
MAINTAIN

SKU: TM431
#3807-0261



Optimate 3

12.8V 0.8A LITHIUM

LOW VOLT SAVE
(FROM 0.5V)

CHARGE & TEST Li

'24/7 365 SAFE'
MAINTAIN

SKU: TM471
#3807-0265



Optimate LFP
lithium 4s 0.8A

ULTIMATE

12V / 12.8V 1.25A GOLD

LOW VOLT SAVE
(FROM 0.5V)

RESET, CHARGE
& TEST Pb Li

'24/7 365 SAFE'
MAINTAIN



Quad program

SELECT PROGRAM 1 OR 3 TO CHARGE
BATTERY DIRECT.

SELECT PROGRAM 2 OR 4 TO CHARGE
THROUGH BMW CAN-BUS CONTROLLED
12V SOCKET.



SKU: TM631-PR #3807-0683
SKU: TM631 #3807-0684

Optimate 4
quad program

Join Us!

For Daily educational videos and images:

 [Facebook.com/OptiMatebatterysavingcharger](https://www.facebook.com/OptiMatebatterysavingcharger)

 @OPTIMATE1

For detailed product videos and how to tips:

 @OPTIMATE1

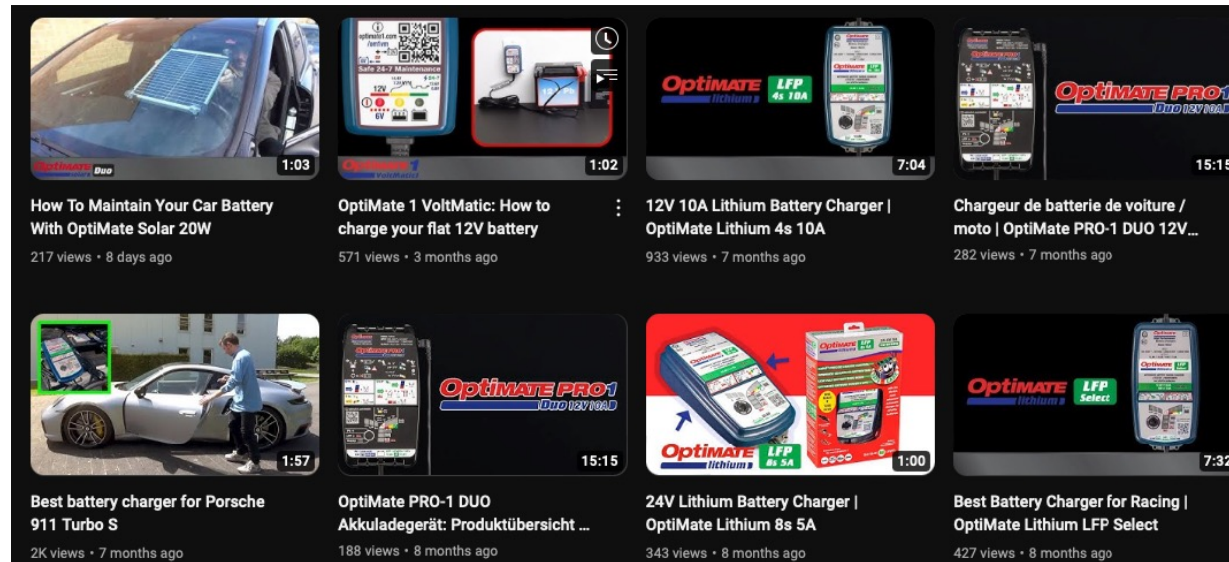

Educational for both you and your dealers!



Martin Human – CEO / CTO (original engineer)

cell: 905-3996087 office: 905-3372095

email: martinhuman@tecmate.com

Shirley Noel – Operations & General Manager (TMNA)

office: 905-3372095 / 1-844-3372095

email: shirleynoel@tecmate.com

Mikey Taylor – Sales & marketing, after sales service

cell: 334-3328075

email: mikeytaylor@tecmate.com

Kevin Perera – Sales & after sales service/warranty

office: 905-3372095 / 1-844-3372095

email: kevinperera@tecmate.com

