

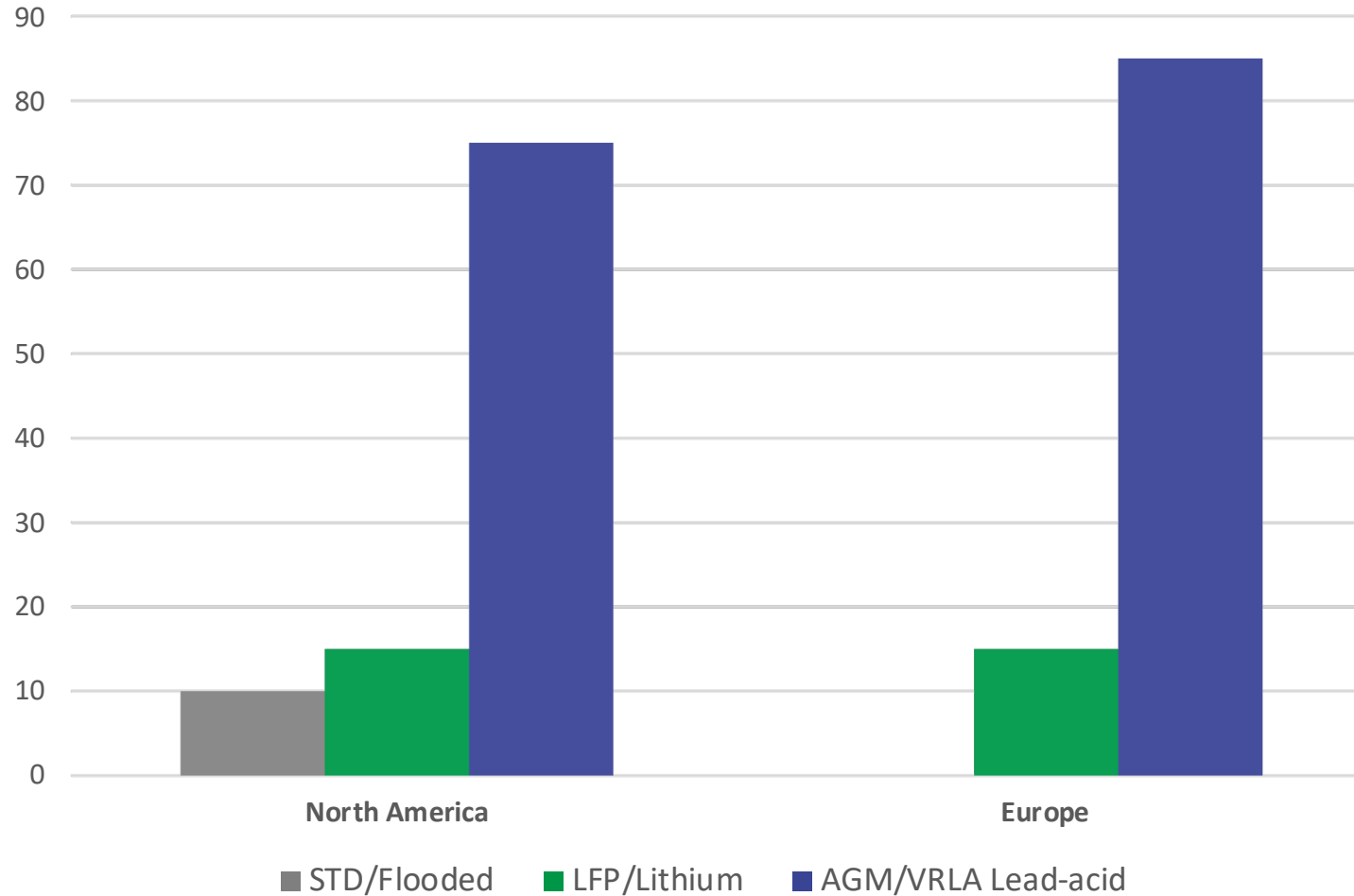





# BATTERY POPULATION



# LITHIUM BATTERY POPULATION

									
TIGER 1200	PANIGALE	S 1000 RR	CRF-450X	350 SX-F	TE 300	KX 250	Stock in every bike	Ryker	YZ-450F
SPEED TRIPLE	1099	M 1000 RR	CRF-250X	450 SX-F	TE 250	KX 450SR			YZ-250F
*250 MX?	V4 R	R 1250 GS	AFRICA TWIN ES	690 ENDURO	FX 350	NINJA			YZ-450FX
*450 MX?		*R 1300 GS?	AFRICA TWIN	300 XC-W	FX 300	KLX 300R			
			CBR1000RR	300 SX					
			CRF-450L						

- ✓ DELIVERED FROM THE FACTORY WITH LITHIUM BATTERY.
- ✓ EVERY MANUFACTURER ADDING MORE BIKES DAILY.
- ✓ ALL BIKES NOW HAVE MORE OPTIONS FOR AFTERMARKET LITHIUM BATTERIES.

# GOOD

Pb 6-cell

12V AGM STD GEL

12V / 12.8V 0.6A BRONZE

LOW VOLT SAVE  
(FROM 4V)

CHARGE Pb Li

'24/7 365 SAFE'  
MAINTAIN

SKU: TM409  
#3807-0431



**Optimate 1**  
DUO

12.8V LFP LiFe LiFePO<sub>4</sub>

Li 4-cell

# BETTER

Pb 6-cell

12V AGM STD GEL

12V / 12.8V 2A BRONZE

LOW VOLT SAVE  
(FROM 4V)

CHARGE Pb Li

'24/7 365 SAFE'  
MAINTAIN

SKU: TM551  
#3807-0572



**Optimate 2**  
DUO 12V 2A

12.8V LFP LiFe LiFePO<sub>4</sub>

Li 4-cell

# BEST

12V 0.8A SILVER

LOW VOLT SAVE  
(FROM 2V)

CHARGE & TEST Pb

'24/7 365 SAFE'  
MAINTAIN

SKU: TM431  
#3807-0261



**Optimate 3**

12.8V 0.8A LITHIUM

LOW VOLT SAVE  
(FROM 0.5V)

CHARGE & TEST Li

'24/7 365 SAFE'  
MAINTAIN

SKU: TM471  
#3807-0265



**Optimate LFP**  
lithium 4s 0.8A

# ULTIMATE

**SOMETHING  
NEW!**

# Optimate4

quad program

## PREMIUM EDITION

12V 1.25A  
9 STEPS  
12.8V 1.25A



TecMate Part # TM631-PR

LeMans Part # 3807-0683 / PC # 3807-0676

MSRP: \$104.95 / CA\$115.95

THE WORLD'S MOST ADVANCED POWER-SPORT BATTERY CHARGER!

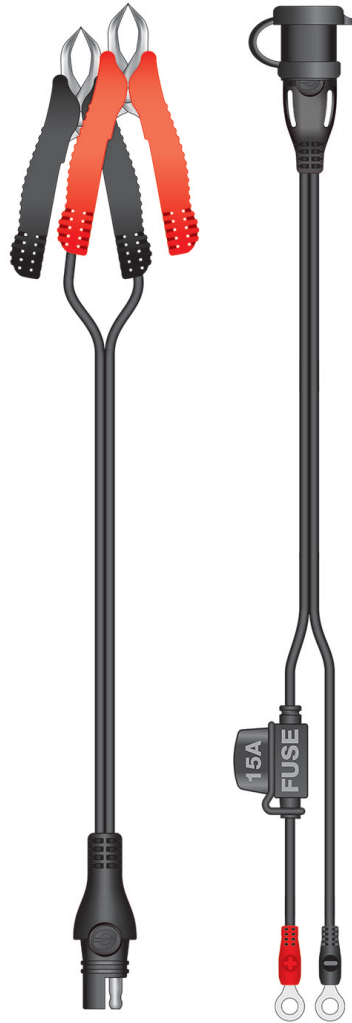
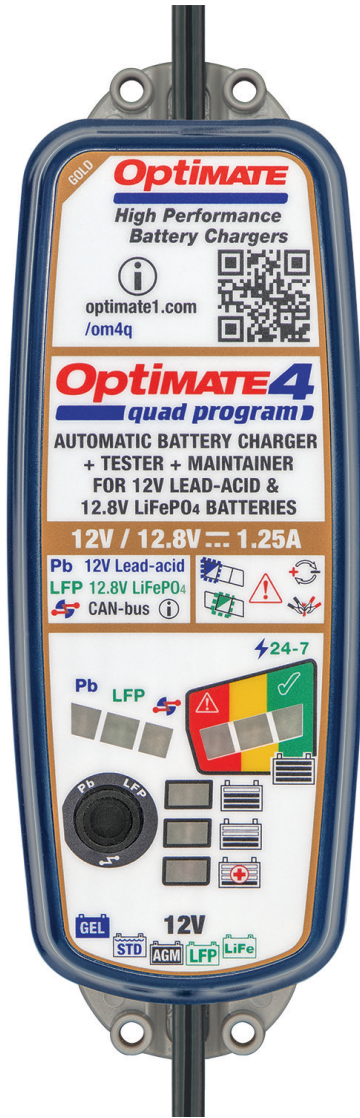

O-04 BATTERY CLIPS  
O-01 BATTER LEAD



O-09 DIN BIKE PLUG



**BMW  
MOTORRAD**



O-411 HANGING HOOK

**OptiMATE4**  
*quad program*

**PREMIUM EDITION**

**12V 1.25A**  
**9 STEPS**  
**12.8V 1.25A**

# *quad program*

TecMate Part # TM631-PR

LeMans Part # 3807-0683 / PC# 3807-0676

MSRP: \$104.95 / CA\$115.95

**THE WORLD'S MOST ADVANCED POWER-SPORT BATTERY CHARGER!**

# THE WORLD'S MOST ADVANCED POWER-SPORT BATTERY CHARGER!

**1**

**SMART DESULPHATION**

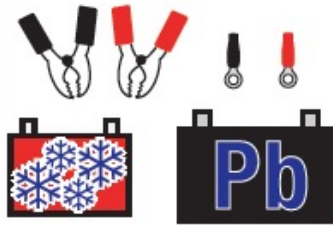

**2**

**BMW CAN-bus  
COMPATIBLE**



**3**

**LOW VOLT RECOVERY**



**4**

**BMW CAN-bus  
COMPATIBLE**

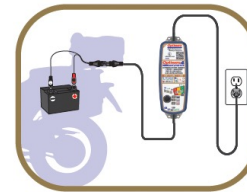
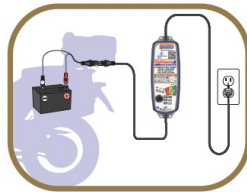

**THE WORLD'S MOST ADVANCED POWER-SPORT BATTERY CHARGER!**

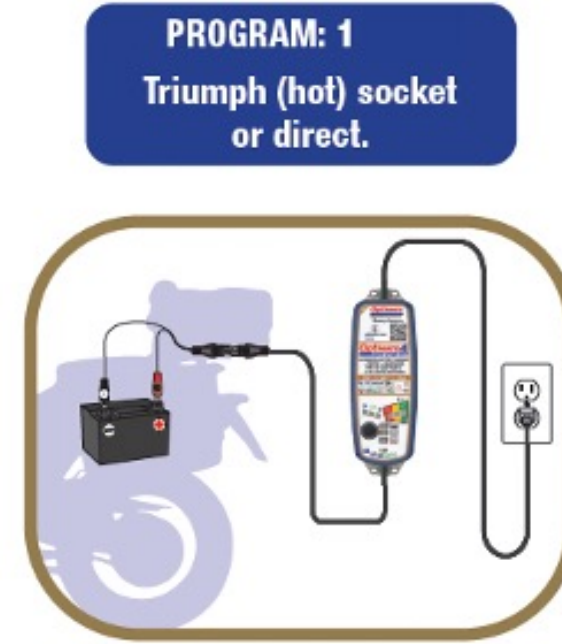

**Pb - Lead-Acid**

**12V** 4 - 60Ah

**AGM** **GEL** **STD**



**THE WORLD'S MOST ADVANCED POWER-SPORT BATTERY CHARGER!**



**PROGRAM: 2  
(BMW CAN-bus)**



**BMW  
MOTORRAD**

**Pb - Lead-Acid**

**12V 4 - 60Ah**

**AGM GEL STD**

**THE WORLD'S MOST ADVANCED POWER-SPORT BATTERY CHARGER!**

**3**  
**LOW VOLT RECOVERY**



LFP **Bms** LFP

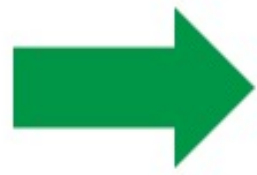

**PROGRAM: 3**  
**Triumph (hot) socket or direct.**

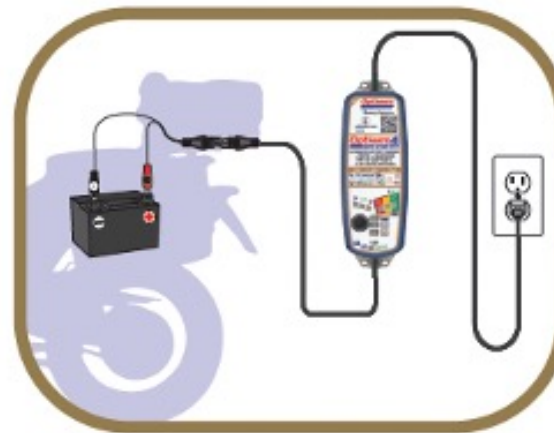

LFP - Lithium :  $\text{LiFePO}_4$

**12.8V** 2 - 15Ah

**LFP** **LiFe**

**THE WORLD'S MOST ADVANCED POWER-SPORT BATTERY CHARGER!**

**4**  
**BMW CAN-bus  
COMPATIBLE**

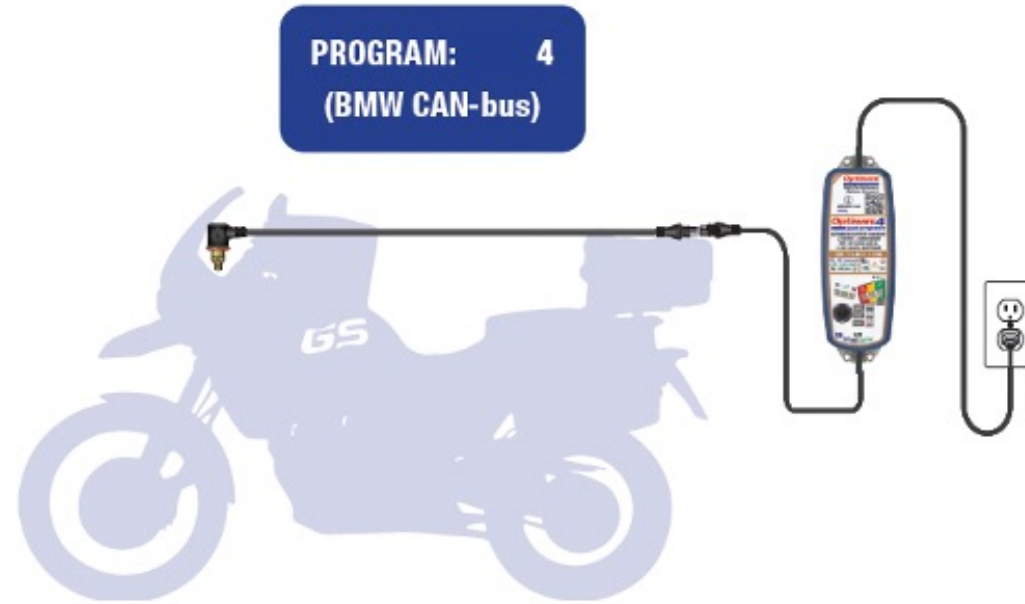

**BMW  
MOTORRAD**

**LFP - Lithium : LiFePO4**

**12.8V 2 - 15Ah**

**LFP LiFe**

# SAVING 'DEAD' BATTERIES / OFF BIKE CHARGING:

**1**  
**SMART DESULPHATION**



The diagram shows a pair of red and black alligator clips connected to a battery. The battery is depicted with a snowflake pattern on the left side and the letters 'Pb' on the right side, representing lead-acid technology.

**3**  
**LOW VOLT RECOVERY**



The diagram shows a pair of red and black alligator clips connected to a battery. The battery is labeled 'LFP' and 'Bms' (Battery Management System), representing lithium iron phosphate technology.

**ALL BIKES  
+  
OUT OF BIKE  
BMW AND TRIUMPH**

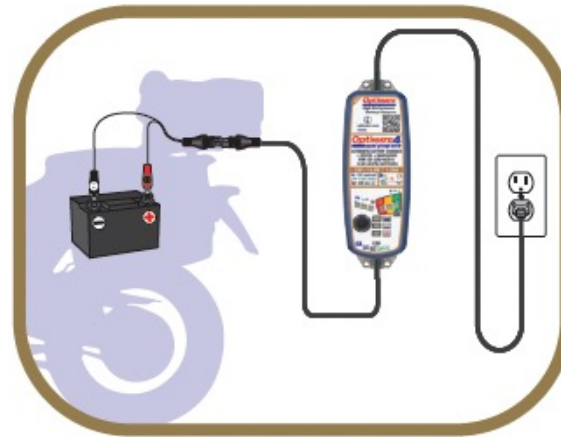

**LOW VOLTAGE SAVE**  
from as low as 0.5V

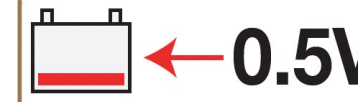

The diagram shows a battery icon with a red bar indicating a low charge level. A red arrow points to the battery with the text '0.5V' next to it.

# IN BIKE CHARGING:

**2**

**BMW CAN-bus  
COMPATIBLE**



**4**

**BMW CAN-bus  
COMPATIBLE**



**BMW  
MOTORRAD**

**PROGRAM: 2 OR 4  
(BMW CAN-bus)**

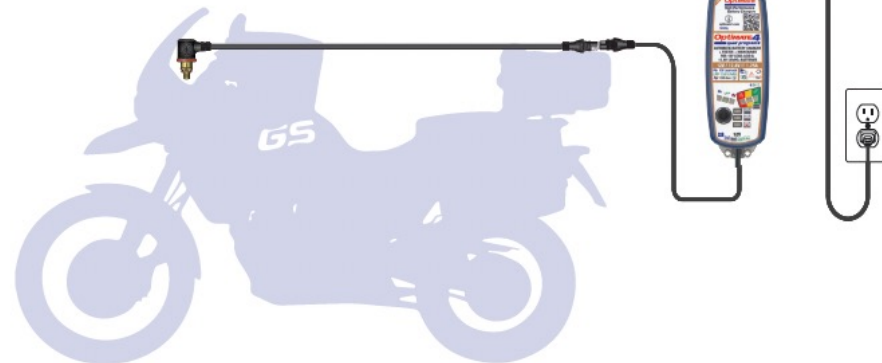

**PROTECTS YOUR BATTERY  
against discharge by vehicle**

**24-7**



**THE WORLD'S MOST ADVANCED POWER-SPORT BATTERY CHARGER!**



# USB CHARGERS

**Optimate**  
USB **O118**

**USB-C**

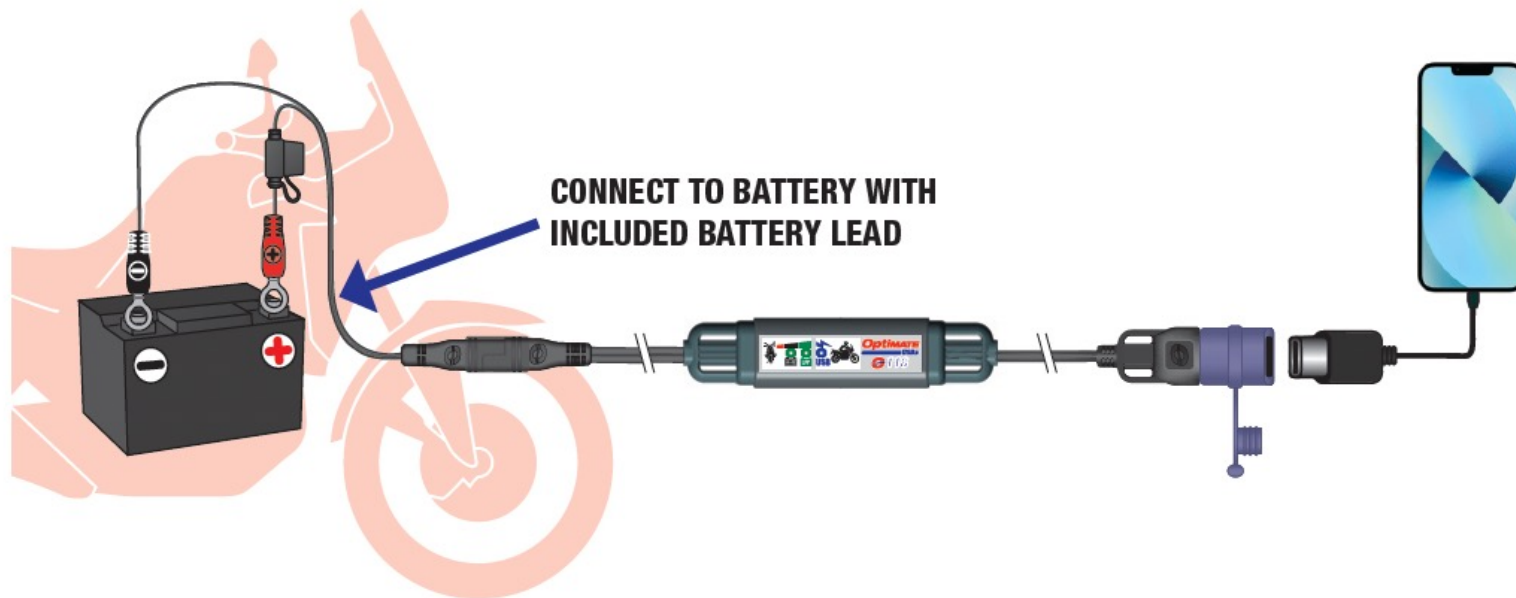

TecMate Part # **O-118**  
LeMans Part # 3807-0664  
MSRP: \$38.95 / CA\$49.95

**WORKS WITH ALL POWERSPORT BATTERIES**

**12V** Pb / AGM  
**12.8V** Li / LFP

**PROTECTS VEHICLE BATTERY** turns on / off automatically

**ON :**   **USB** ✓  
**OFF:**   **USB** ✗

**TESTS VEHICLE BATTERY** ready to start engine ✓





# USB CHARGERS

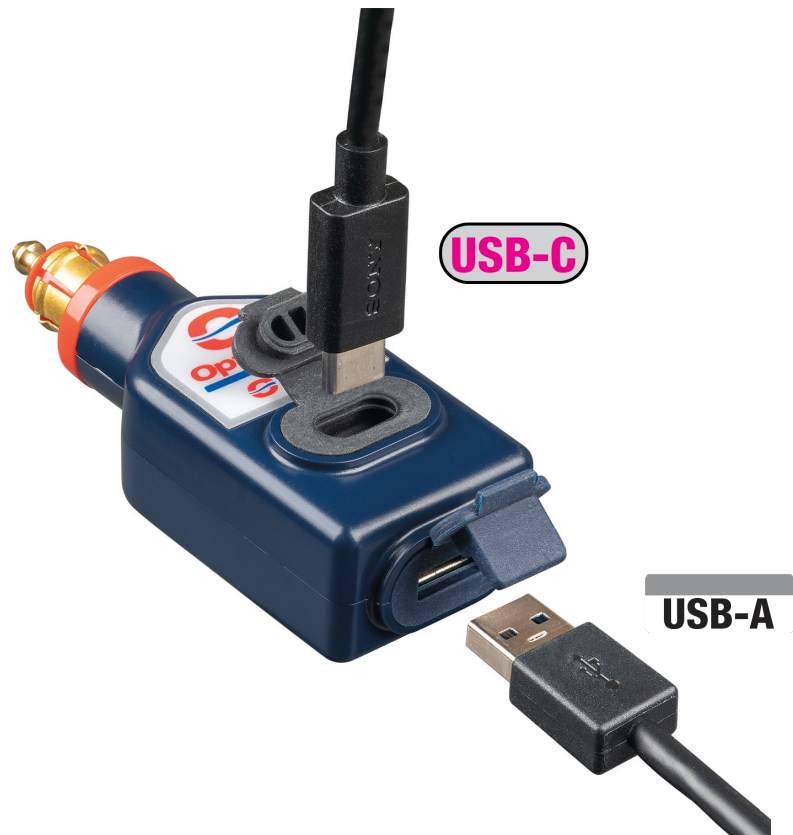

USB-C

USB-A

TecMate Part # **O-114**  
 LeMans Part # 3807-0686  
 MSRP: \$29.95 / CA\$38.95



USB-C

USB-A

TecMate Part # **O-119**  
 LeMans Part # 3807-0687  
 MSRP: \$29.95 / CA\$38.95



USB-A

USB-C



WORKS WITH ALL POWERSPORT BATTERIES

**12V** Pb / AGM

**12.8V** Li / LFP

PROTECTS VEHICLE BATTERY turns on / off automatically

ON:  $\geq 13.3V$  USB

OFF:  $12V$  USB





# TESTERS

**BATTERY GOOD? No more guessing!**





# TESTERS

## KNOW WHEN TO RECHARGE YOUR BATTERY



**LED blinks next to battery type.**



**Charge when LED below blinks.**



# TESTERS

**Optimate**  
*monitor* **O 126**

Battery status / charge system monitor  
for 12V lead-acid & 12.8V lithium-ion,  
with AUTO/DIN plug.

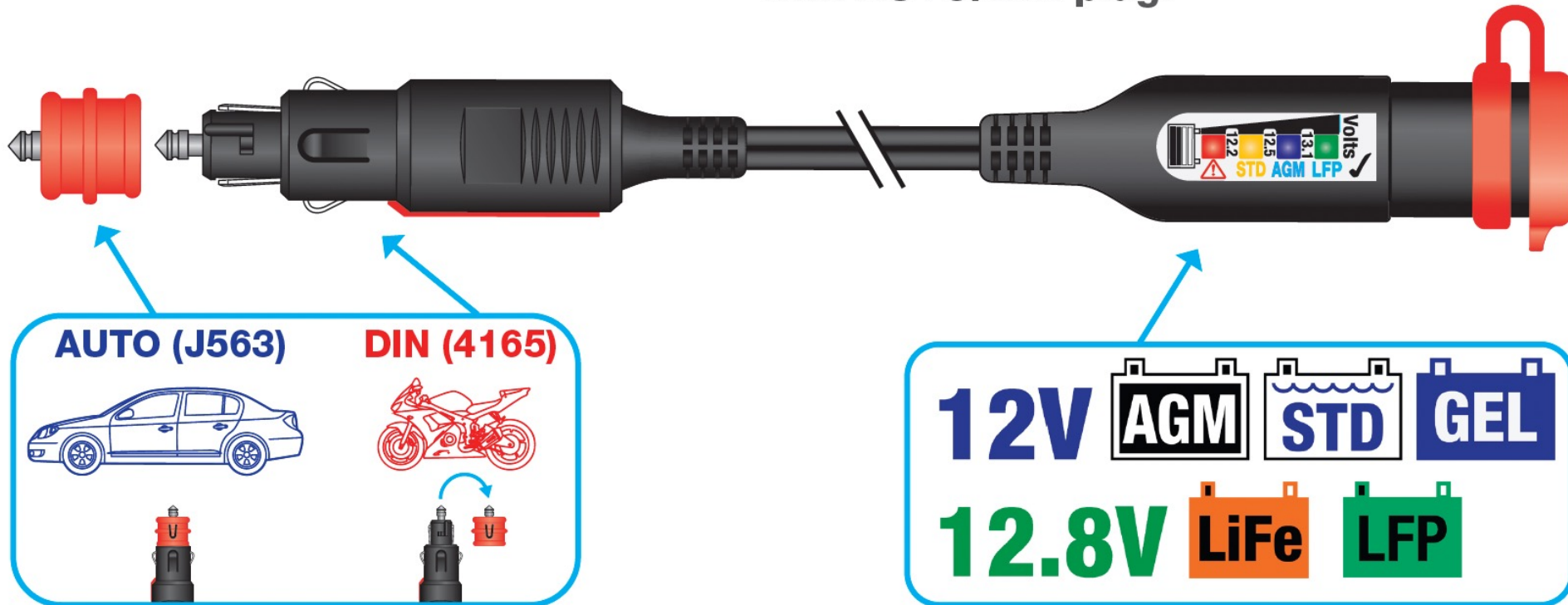

**AUTO (J563)**



**DIN (4165)**

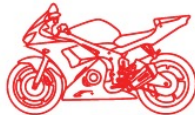

**12V**



**12.8V**



TecMate Part # **O-126v2**  
LeMans Part # 3807-0663  
MSRP: \$22.95 / CA\$28.95



# TESTERS

**Optimate**  
monitor  **125**

Plugs directly into any industry standard SAE battery lead!

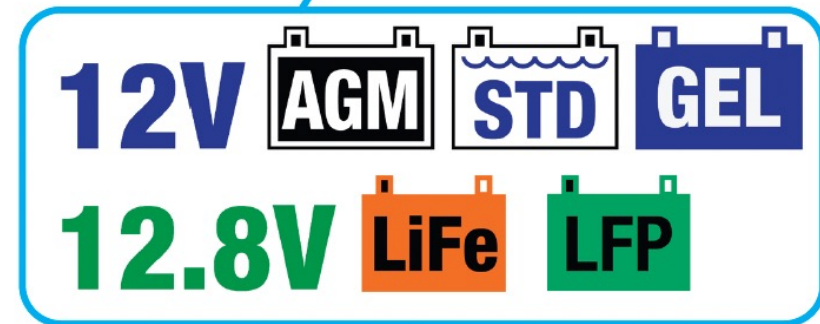

TecMate Part # **O-125v2**  
LeMans Part # 3807-0663  
MSRP: \$17.95 / CA\$23.95



# TESTERS

NEW!

**AS easy as 1-2-3!**

1. Check state of battery
2. Check cranking/starter voltage
3. Check charge/running voltage

- ✓ *Improved programming.*
- ✓ *Easier identification of battery condition.*
- ✓ *The ultimate electrical testing too!*



TecMate Part # **TS-121**  
LeMans Part # 3807-0245  
MSRP: \$43.95 / CA\$51.95

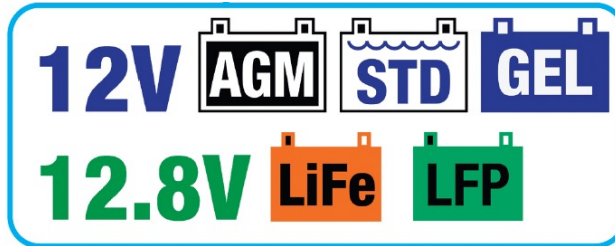

# SLIM BATTERY LEAD

**Optimate**  
cable

**0-31s JAR (BLACK + GREEN CAP)**

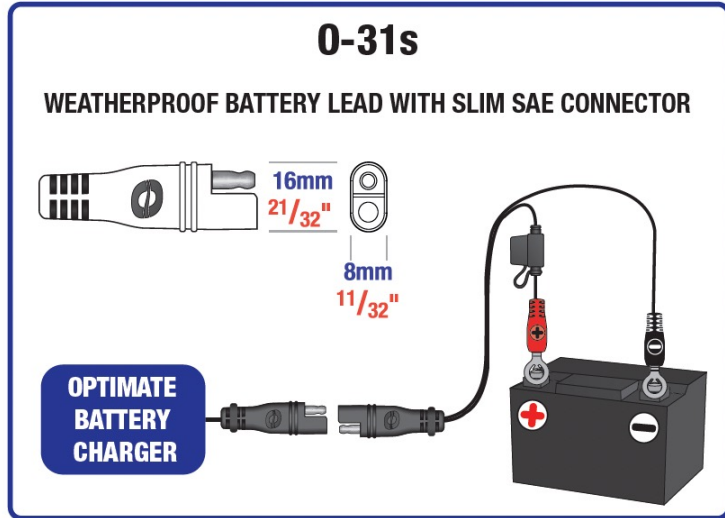

**Standard:**

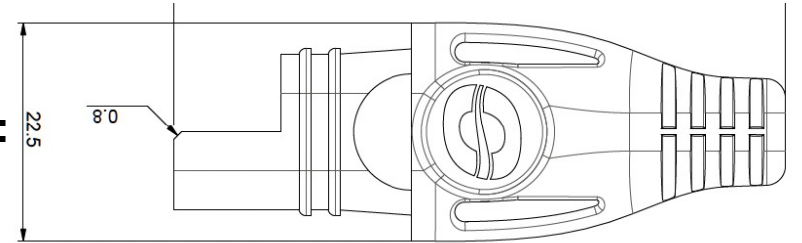

**SLIM:**

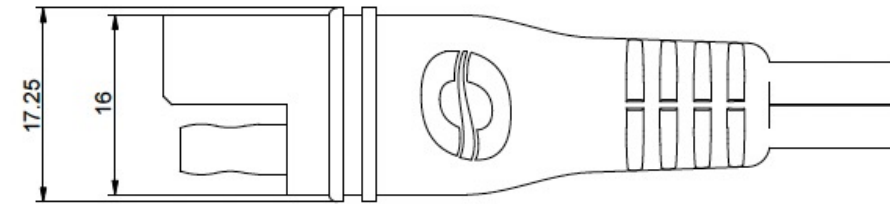

**POWERSPORT / MOTO**  
**M6 (1/4")**

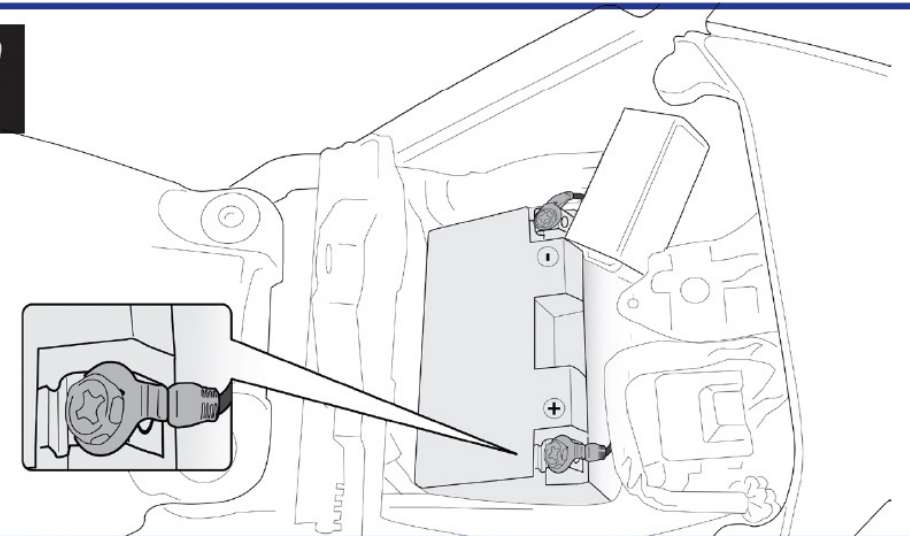

TecMate Part # **O-31sJAR**

LeMans Part # 3807-0685 / 3807-0677 CAN

MSRP: \$144.95 / CA\$166.95

## BATTERY LEAD SELECTOR



1/4" (M6)

### POWERSPORT



#### BUYING OPTIONS

QTY	MFG#	PART#
20 UNITS	0-01JAR	#3807-0241
20 UNITS	0-31JAR	#3807-0577
20 UNITS	0-31sJAR	#3807-0685 #3807-0677 (CAN)



QTY	MFG#	PART#
1 UNIT	0-01M	#3807-0259



QTY	MFG#	PART#
1 UNIT	0-01D	#3807-0256
20 UNITS	0-01DJAR	#3807-0352
120 UNITS	0-01DJARx6	#3807-0537

1/4" (M6) / 5/16" (M8)

### DUAL RING TECHNOLOGY

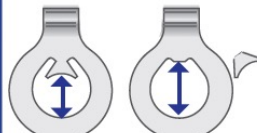

#### BUYING OPTIONS

QTY	MFG#	PART#
1 UNIT	0-01	#3807-0159
4 UNITS	0-01x4	#3807-0424
20 UNITS	0-01NJAR	#3807-0540
100 UNITS	0-01x100BOX	#3807-0060
120 UNITS	0-01NJARx6	#3807-0599



QTY	MFG#	PART#
1 UNIT	0-01NMJAR	#3807-0536
120 UNITS	0-01NMJARx6	#3807-0547

5/16" (M8) / 3/8" (M10)

### DUAL RING TECHNOLOGY



#### BUYING OPTIONS

QTY	MFG#	PART#
1 UNIT	0-11	#3807-0419
4 UNITS	0-11x4	#3807-0427



**WINTER IS COMING**



# GOOD

Pb 6-cell

12V AGM STD GEL

12V / 12.8V 0.6A BRONZE

LOW VOLT SAVE  
(FROM 4V)

CHARGE Pb Li

'24/7 365 SAFE'  
MAINTAIN

SKU: TM409  
#3807-0431



**Optimate 1**  
DUO

12.8V LFP LiFe LiFePO<sub>4</sub>

Li 4-cell

# BETTER

Pb 6-cell

12V AGM STD GEL

12V / 12.8V 2A BRONZE

LOW VOLT SAVE  
(FROM 4V)

CHARGE Pb Li

'24/7 365 SAFE'  
MAINTAIN

SKU: TM551  
#3807-0572



**Optimate 2**  
DUO 12V 2A

12.8V LFP LiFe LiFePO<sub>4</sub>

Li 4-cell

# BEST

12V 0.8A SILVER

LOW VOLT SAVE  
(FROM 2V)

CHARGE & TEST  
Pb

'24/7 365 SAFE'  
MAINTAIN

SKU: TM431  
#3807-0261



**Optimate 3**

12.8V 0.8A LITHIUM

LOW VOLT SAVE  
(FROM 0.5V)

CHARGE & TEST Li

'24/7 365 SAFE'  
MAINTAIN

SKU: TM471  
#3807-0265



**Optimate** LFP  
lithium 4s 0.8A

# ULTIMATE

12V / 12.8V 1.25A GOLD

LOW VOLT SAVE  
(FROM 0.5V)

RESET, CHARGE  
& TEST Pb Li

'24/7 365 SAFE'  
MAINTAIN



**Quad program**

SELECT PROGRAM 1 OR 3 TO CHARGE  
BATTERY DIRECT.

SELECT PROGRAM 2 OR 4 TO CHARGE  
THROUGH BMW CAN-BUS CONTROLLED  
12V SOCKET.



SKU: TM631-PR #3807-0683  
SKU: TM631 #3807-0684

**Optimate 4**  
quad program

# JOIN US!

For Daily educational videos and images:

 [Facebook.com/OptiMatebatterysavingcharger](https://www.facebook.com/OptiMatebatterysavingcharger)

 @OPTIMATE1

For detailed product videos and how to tips:

 @OPTIMATE1

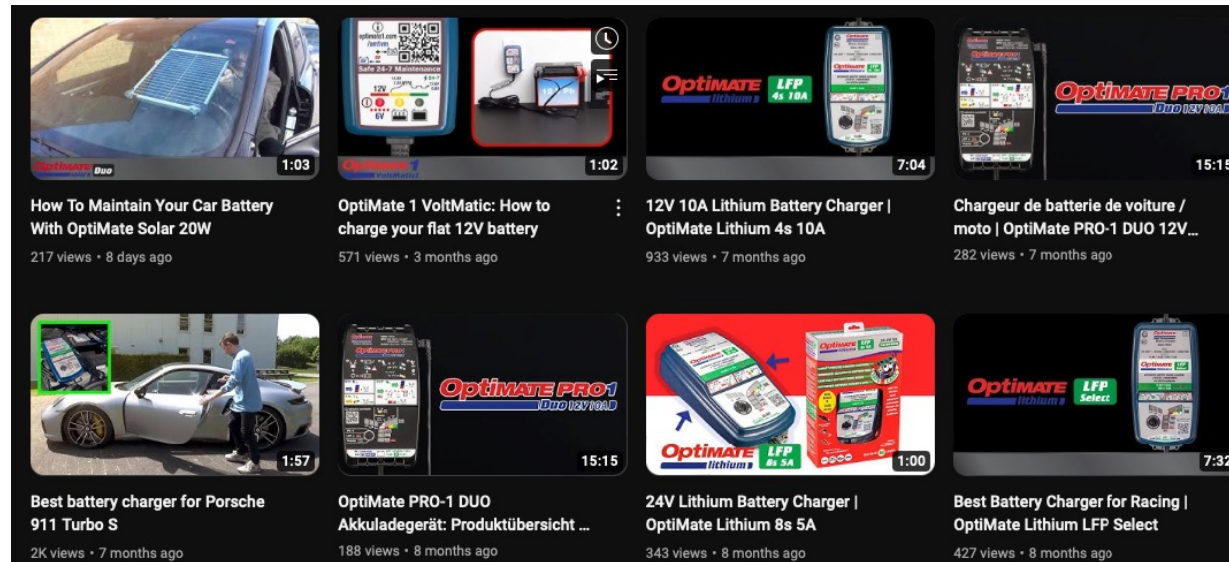

**Educational for both you and your dealers!**



**Martin Human** – CEO / CTO (original engineer)

cell: 905-3996087 office: 905-3372095

email: [martinhuman@tecmate.com](mailto:martinhuman@tecmate.com)

**Shirley Noel** – Operations & General Manager (TMNA)

office: 905-3372095 / 1-844-3372095

email: [shirleynoel@tecmate.com](mailto:shirleynoel@tecmate.com)

**Mikey Taylor** – Sales & marketing, after sales service

cell: 334-3328075

email: [mikeytaylor@tecmate.com](mailto:mikeytaylor@tecmate.com)

**Kevin Perera** – Sales & after sales service/warranty

office: 905-3372095 / 1-844-3372095

email: [kevinperera@tecmate.com](mailto:kevinperera@tecmate.com)